



# HERITAGE SCH

## Installation & Maintenance

## Installation Instructions

### 1.0 General

- 1.1 It is important these Installation and Maintenance Instructions are fully adhered to.
- 1.2 Full details of the unit supplied are shown on the product nameplate. If in doubt about any detail contact Elta Fans Ltd or its agents for clarification.
- 1.3 All electrical installation must be carried out by suitably qualified and competent personnel in accordance with all current statutory requirements.
- 1.4 These instructions cover only the Elta Fans Ltd product and do not include the supply or installation of any safety equipment that may be required e.g. adequate guarding or protection from rotating parts and proper electrical isolation.
- 1.5 Any declarations made by Elta Fans Ltd about product installation and safety, are dependant on the fan equipment being used within installations which themselves meet the requirements of the relevant Standards and Directives of your region.
- 1.6 The fan is designed for use in an ambient temperature of -20°C up to a maximum of +50°C (refer to the relevant table) and up to 95% relative humidity. The fan is not suitable for corrosive or explosive atmospheres.
- 1.7 The installer should provide easy access to the fan to facilitate future maintenance.
- 1.8 The installer should ensure the fan is adequately supported.
- 1.9 This product is not intended for use by persons (including children) with reduced physical, sensory or mental capabilities, or lack of experience and knowledge, unless they have been given supervision or instruction concerning use of the product by a person responsible for their safety. Children should be supervised to ensure that they do not play with the product.
- 1.10 At end-of-life, the unit must be disposed of in an environmentally friendly manner by suitably qualified and competent personnel in accordance with the requirements of applicable Standards and Directives.

### 2.0 Installation

**WARNING** – The fan must be isolated from the power supply during installation and maintenance. The fan must be earthed in accordance with the local regulations.

- 2.1 Upon receipt, the fan equipment should be visually inspected to check for any damage. Ensure that the impeller is free to rotate.
- 2.2 If there are any queries concerning the fan equipment, Elta Fans Ltd should be contacted prior to the installation.
- 2.3 The fan must be securely mounted in the desired position to suit the application. The fan can be mounted on flat or inclined roofs with a maximum pitch angle of 30°.
- 2.4 Position the assembled roof fan unit onto the curb and secure to the timber sill with M10 coach bolts (not supplied by Elta Fans), ensuring that fibre washers are positioned under each bolt head. It is advisable to drill pilot holes prior to fitting the bolts to prevent splitting the timber curb.
- 2.5 Check the details on the motor rating plate to ensure that the correct power supply (voltage, frequency and phase) is available. An incorrect power supply will lead to permanent damage to the fan motor.
- 2.6 Refer to the appropriate wiring diagram. Ensure that all earth connections are made.
- 2.7 Means for electrical disconnection must be incorporated in the wiring installation in accordance with the relevant wiring and electrical regulations.
- 2.8 Precaution must be taken to locate the exhaust discharge terminal so as to avoid the backflow of gases into the room from the open flue of gas or other fuel burning appliances.

### 3.0 Start Up

- 3.1 Before power is supplied to the unit, check that the wiring is correct as per the fan connection diagram.
- 3.2 At initial start-up, check that impeller rotation and airflow direction is correct.
- 3.3 Check that the motor amperage draw does not exceed the nameplate rating.

### 4.0 Fan Maintenance

- 4.1 Inspection of the fan at least once every 12 months is recommended to ensure that the motor, fan blades, and supporting guards, are clean. Any build up of dust and deposits on the blades or guards should be removed using a non-abrasive cleaner.
- 4.2 All fastenings should be checked for tightness. In addition, all rotating items should be checked.
- 4.3 Bearings are of the 'sealed for life' type and will not need a detailed inspection.

**WARNING** – This fan is fitted with an auto-reset thermal contact which switches the fan off in the event of a fault condition. Once the motor cools down the fan may start unexpectedly. Only a suitably qualified and competent person may carry out maintenance after the electrical supply has been isolated.

## Installation Instructions

**Table 1: Operational Maintenance**

Product Code	Wiring Diagram No.
Inspect AV mounts for Corrosion or “Sag”	6 months
Check earth bonding	6 months
Dampers check rubber stops and grease (lithium based) pivot points, by removing plastic caps	Yearly
Check fixings tightness and conditions of brass track and rivets	26,000 hours / 3 years
Inspect and clean impeller	26,000 hours / 3 years
Remove dirt from motor cooling fins	26,000 hours / 3 years
Check operation of anti-condensation heaters	26,000 hours / 3 years
Check for even tip clearance between impeller and casing – For ATEX 10% of motor shaft diameter with 2mm minimum and 13mm maximum.	26,000 hours / 3 years
Check motor Amps	26,000 hours / 3 years
Any corrosion - treat with suitable chemicals	26,000 hours / 3 years
Check casing seals	26,000 hours / 3 years

**Table 2: Terminal Box Maintenance**

Activity	Frequency
Check that lid seal is in place and not damaged	Each time the enclosure is opened
Check that lid fixing screws are in place and secured	Each time the enclosure is closed
Check that the mounting bolts are tight and free from corrosion	Annually
Check security of all cable glands	Annually
Check that all screw clamps terminals are secure	Annually and each time enclosure is opened
Check enclosure for damage	Annually

### 5.0 Storage

- 5.1 If the fan is not to be used immediately then it should be stored in a clean, dry, vibration free and lockable location.
- 5.2 The impeller must be spun by hand (ensuring that it does not come to rest in the same position) on a monthly basis to prevent hardening of the grease and possible damage to the bearings.
- 5.3 All items to be stored on pallets that afford adequate protection from damage, dust and high humidity.
- 5.4 If storage periods of longer than 1 month are anticipated then Elta (or their Agent) should be contacted prior to storage taking place, to ensure the storage area provisions will not be detrimental to the well being of Elta products.

### 6.0 Guarantee

Elta Fans Ltd will, free of charge, within a period of 1 year from the date of dispatch from their works, repair or at its option replace any goods which are proved to have defects as a result of defective materials or workmanship. The goods MUST be returned to Elta Fans Ltd carriage paid for examination.

## Wiring Diagrams

Please use the table(s) below to match up the product code and the wiring diagram number.

### Single Phase 220V - 240V / 50Hz

Page No.	Product Code	Wiring Diagram No.
5	<a href="#">SCH315/4-2</a>	152-511
5	<a href="#">SCH315/6-2</a>	152-511
5	<a href="#">SCH350/4-2</a>	152-511
5	<a href="#">SCH350/6-2</a>	152-511
5	<a href="#">SCH400/4-2</a>	152-511
5	<a href="#">SCH400/6-2</a>	152-511
5	<a href="#">SCH450/4-2</a>	152-511
5	<a href="#">SCH450/6-2</a>	152-511
5	<a href="#">SCH500/6-2</a>	152-511
5	<a href="#">SCH560/6-2</a>	152-511

### Three Phase 380V - 415V / 50Hz

Page No.	Product Code	Wiring Diagram No.
6	<a href="#">SCH315/4-3</a>	152-609
6	<a href="#">SCH315/6-3</a>	152-609
6	<a href="#">SCH350/4-3</a>	152-609
6	<a href="#">SCH35064-3</a>	152-609
6	<a href="#">SCH400/4-3</a>	152-609
6	<a href="#">SCH400/6-3</a>	152-609
6	<a href="#">SCH450/4-3</a>	152-609
6	<a href="#">SCH450/6-3</a>	152-609
6	<a href="#">SCH500/4-3</a>	152-609
6	<a href="#">SCH500/6-3</a>	152-609
6	<a href="#">SCH560/4-3</a>	152-609
6	<a href="#">SCH560/6-3</a>	152-609
6	<a href="#">SCH630/4-3</a>	152-609
6	<a href="#">SCH630/6-3</a>	152-609

# 152-511

## Wiring Diagrams



FIXED SPEED CONNECTION

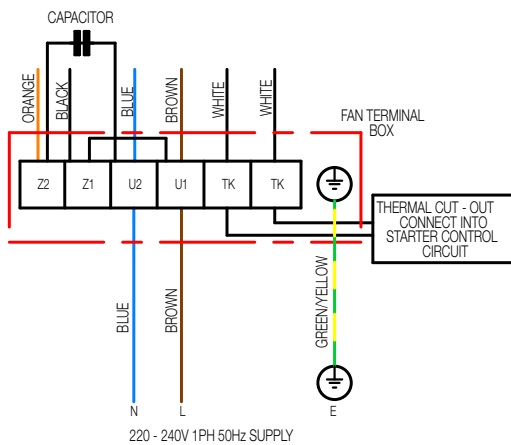

VARIABLE SPEED CONNECTION CONTROLLER TYPES EL31 TK, EL61 TK

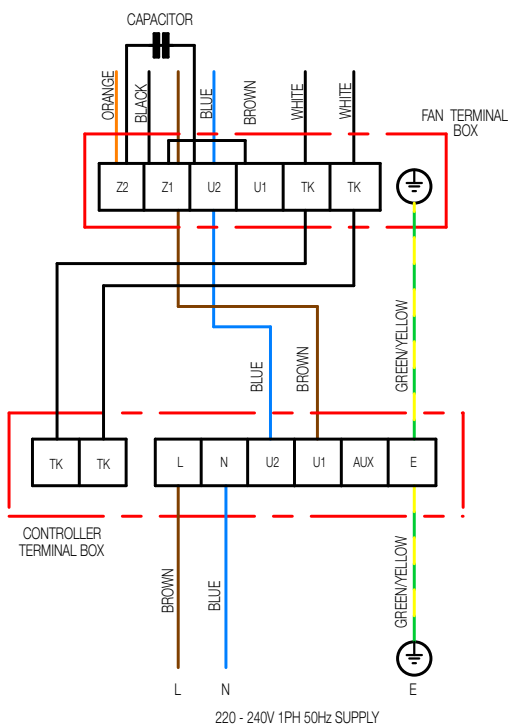

VARIABLE SPEED CONNECTION CONTROLLER TYPE TC12, TC14, TC18, TC110, TC112

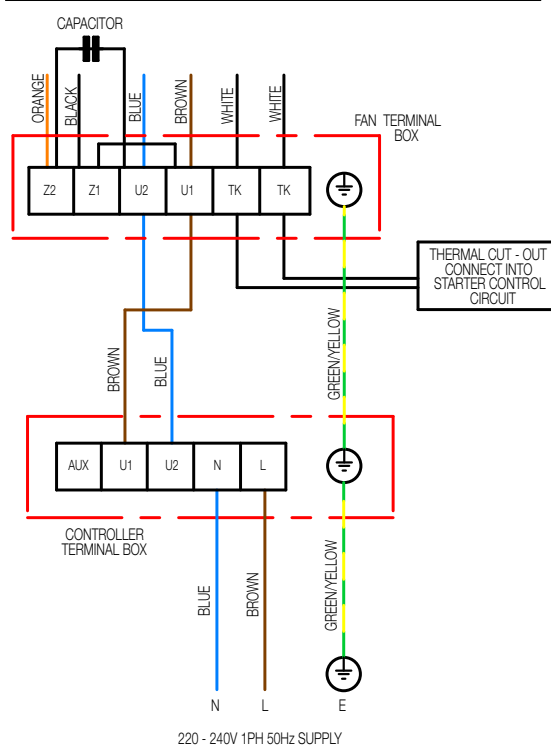

ALL WIRING AND CONTROL EQUIPMENT MUST COMPLY TO THE LATEST IEE REGULATIONS, IN PARTICULAR PART 552-01-02/03

MK-152-511

Issue: C

Saved Date:

15/07/2013

Check the individual product accessories table for fan controller compatibility

Elta Fans Limited has a policy of continuous product development and improvement and therefore reserves the right to supply products which may differ from those illustrated and described in this publication. Confirmation of dimensions and data will be supplied on request.

# 152-609

## Wiring Diagrams



### FIXED SPEED CONNECTION

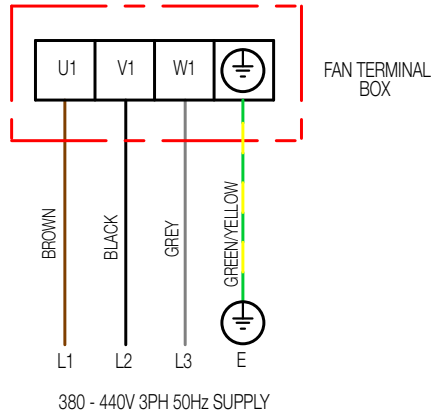

### VARIABLE SPEED CONNECTION CONTROLLER TYPE TC33, TC35, TC310

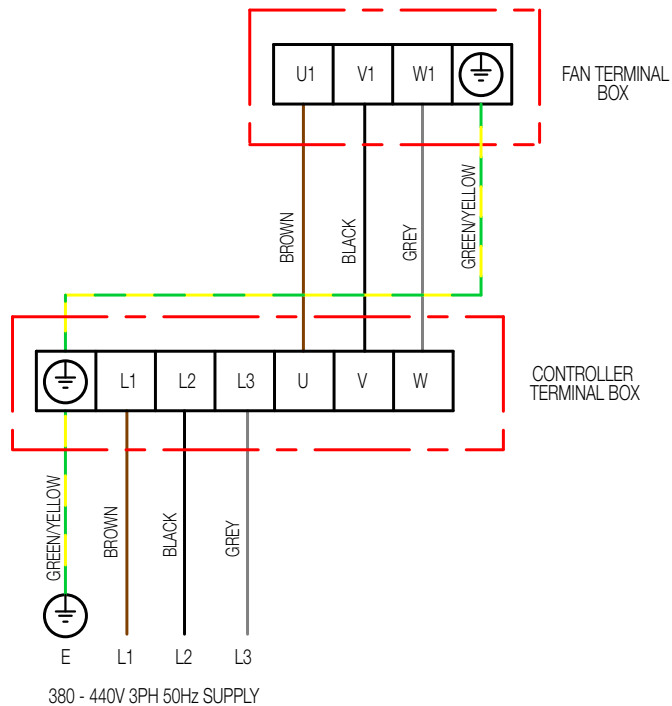

ALL WIRING AND CONTROL EQUIPMENT MUST COMPLY TO THE LATEST IEE REGULATIONS, IN PARTICULAR PART 552-01-02/03

MK-152-609

Issue: 3



Saved Date: 15/07/2013

Check the individual product accessories table for fan controller compatibility

# EC Declaration of conformity/incorporation



Herewith we declare that the air movement equipment below, on the basis of its design and construction as partly completed machines brought onto the market complies with relevant health and safety requirements of the EC Directives stated below. In the event that alterations are made to the machinery without prior consent from Elta Fans Ltd, this declaration becomes invalid.

EC Declaration of Conformity	EC Declaration of Incorporation
<p><b>Description of Equipment:</b> Building Services Ranges - Air movement fan</p> <p><b>Equipment model numbers for safe area fans:</b> SCP, SPA, SAX, SCD, SDA, SCC, SLC, SCPP, SPP, SAMF, HIT, SEM, SEL, ISEO IMF, SH, SSD, SQS, SQSDCV, SQU, SMB, STD, SQT, SQT-DCV, SCH, SCHAT, SSTR, SSTRDCV, STDR, STDRDCV, SB, SQU-HT, SSQU-HT, SDF, ZFHIC, SRC</p> <p><b>Relevant / applied directives:</b> Machinery directive 2006/42/EC, Low voltage directive 2014/35/EU</p> <p><b>Relevant / applied directives where applicable:</b> Energy related products directive 2009/125/EC (when used in Europe) Electromagnetic compatibility directive 2014/30/EU (where driven via Inverter)</p> <p><b>Relevant / applied directives where applicable:</b> BS EN ISO 12100 : 2010 BS EN 14694 : 2003 + A1 : 2011 BS EN 308:1997 BS EN ISO 5801:2008</p>	<p>In accordance with the Machinery Directive 2006/42/EC;</p> <p>The design of the partly completed machine, listed above, complies with the Essential Health and Safety Requirements (EHSRs) of ANNEX I, sections 1.1.2, 1.1.5, 1.4.1, 1.5.1 in EC Machinery Directive 2006/42/EC.</p> <p>Machinery is incomplete and must not be put into service until such time as the machinery which is partly complete, is to be incorporated, and has been assessed and Declared in Conformity with the provisions of any relevant parts of the Machinery Directive.</p> <p>We undertake to transmit, upon reasoned request by appropriate national authorities, relevant information relating to the partly completed machinery identified above.</p>
<p><b>Manufacturer:</b> Elta Fans Limited 46 Third Avenue Pensnett Trading Estate Kingswinford West Midlands DY6 7US United Kingdom</p> <div style="text-align: right;">  </div>	
<p><b>Date / Signature of Manufacturer:</b></p> <div style="text-align: center;">  </div> <p>Name / Position of Signatory: Mr. Robert Rees Q.A.Manager Elta Fans Ltd This is an electronic document and is valid without a signature or date.</p>	<p><b>Document last revised:</b> 28th March 2017</p> <p style="text-align: right;"><b>Issue Status B</b></p>

## Building Services

Tel **+44 (0) 1384 275800**  
Fax **+44 (0) 1384 275810**  
Email **bs@eltafans.co.uk**

46 Third Avenue, Pensnett Trading Estate, Kingswinford,  
West Midlands, DY6 7US United Kingdom

## Applied Technology & Building Services Export

Tel **+44 (0) 1489 566500**  
Fax **+44 (0) 1489 566555**  
Email **at@eltafans.co.uk / export@eltafans.co.uk**

17 Barnes Wallis Road, Segensworth East Industrial Estate,  
Fareham, Hampshire, PO15 5ST United Kingdom

**eltafans.com**

535-IOM0035 Issue A



BS EN ISO 9001:2008 FM 556465

