

IMF

In-line Mixed Flow Fan

IMF SERIES

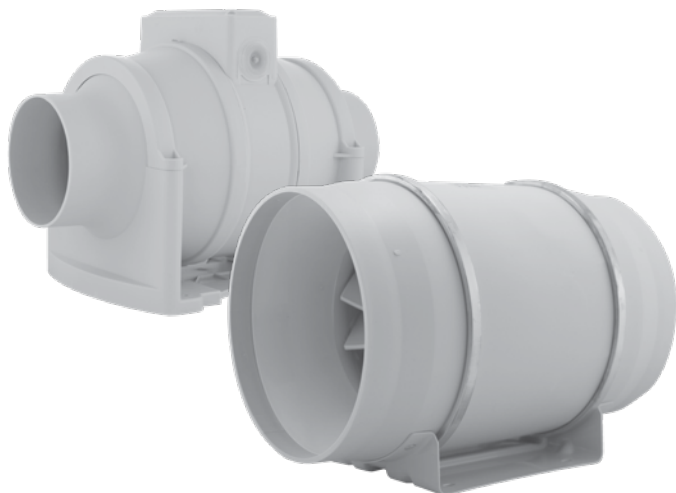

How To Order



100, 125, 150 & 200 Models

Motor

Type - 2 speed, induction.
Electricity supply - single phase 220-240V 50hz or 220V 60Hz.
Bearings - ball.
Maximum ambient temperature - 50°C.
Class II insulation, IP44 rated.

Internal Thermal Protection

Model 100, 125, 150 and 200 - one shot thermal fuse.

Testing

Airflow to ISO 5801:2007
Noise to BS 848 Part 2:1985

Suggested Specification

The in-line fans shall be of the IMF Series as supplied by Elta Fans and be of the models shown. It shall have single-phase induction motor with built in thermal protection and double insulated so no earth connection is required. Fan housing and impeller are made from high quality plastic. Motors and impellers are balanced to ISO 14694 Grade G6.3. All models shall be fully tested to ISO 5801:2007 for Airflow and BS848 Part 2:1985 for noise.

250 & 350 Models

Motor

Type - 2 speed, induction.
Electricity supply - single phase 230V 50Hz.
Bearings - ball.
Maximum ambient temperature - 50°C.
Class F insulation, IP44 rated.

Internal Thermal Protection

Model 250, 315 - auto-reset integral thermal protection.

Testing

Data accurate to suspension free air test at 3m, contact your local office for more information.

Description

The IMF Series are a range of in-line mixed flow fans with a compact profile. This means they offer excellent pressure development characteristics. They have been designed specifically for use with rigid or flexible ductwork and can be used for a wide variety of residential and commercial applications. Available in 6 sizes to suit 100, 125, 150, 200, 250 and 315mm duct.

Typical Applications

Exhaust from bathrooms, toilets, laundries, kitchens and other small to medium spaces in houses, hotels and apartments.

Features

- All plastic casing provides a long lasting, robust and non-corrosive construction.
- Unique mixed flow impeller with fixed blade angles designed to overcome the resistances of long ducting systems and creates top silent operation.
- Units have been constructed from shockproof, heat resistant white plastic, with both motor and impeller mounted within the unit casing.
- Single-phase induction motor with integral thermal protection, mounted on sealed for life high quality sleeve bearings.
- Wired terminal box mounted on the outside of the unit casing, for ease of connection
- Double insulated so no earth connection is required. Available in Standard and run-on timer versions.
- Suitable for continuous and intermittent running.
- Comes with 2 year warranty.
- Mounting bracket is supplied as standard.

Construction

Fan housing and impeller are made from high quality plastic which is shock proof and long lasting.

Finished in white RAL 9010 and UV resistant.

Ancillary Equipment

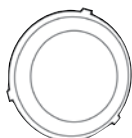

Ceiling Grilles
Ref. Section L



Ducting, Louvres & Grilles
Ref. Section L

Technical Data

Model Number		Free Air m ³ /sec	FanSpeed rev/sec	Watts	Avg. dB(A) @ 3m
100	High	0.065	38	27	45
	Low	0.057	33	27	41
125	High	0.098	38	34	43
	Low	0.082	33	34	38
150	High	0.163	40	67	48
	Low	0.123	32	67	43
200	High	0.258	41	120	57
	Low	0.222	38	120	53
250	High	0.390	40	225	66
	Low	0.295	30	165	58
315	High	0.612	39	390	69
	Low	0.486	27	275	61

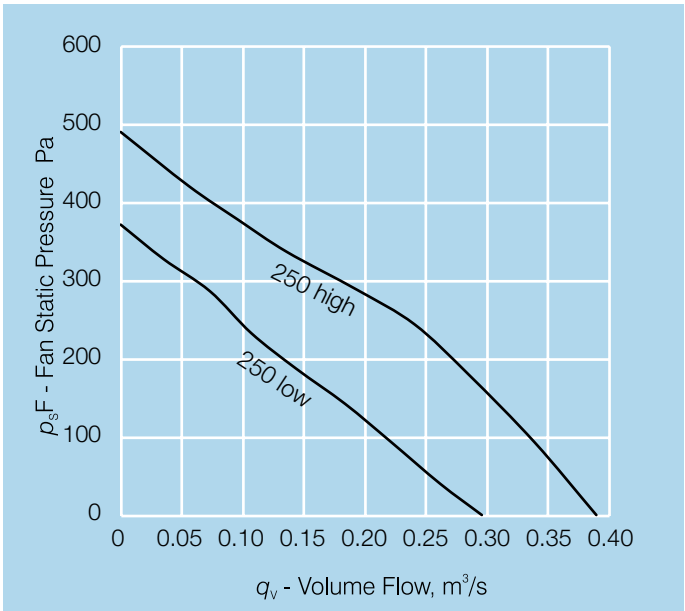
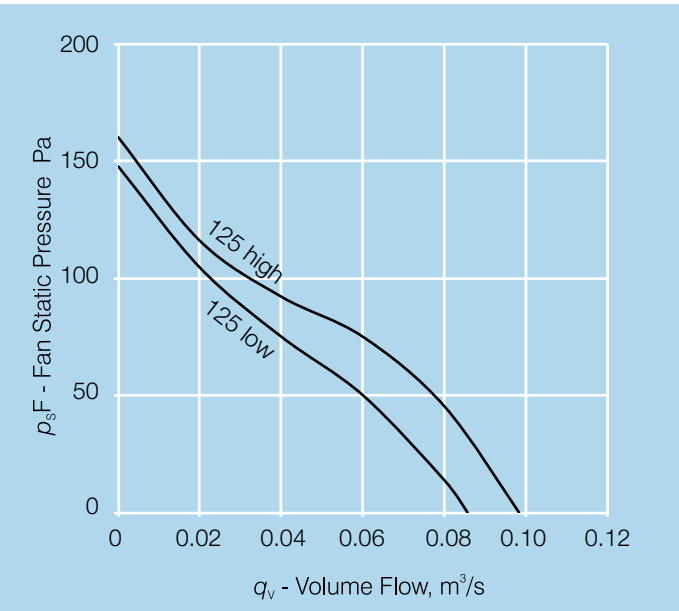
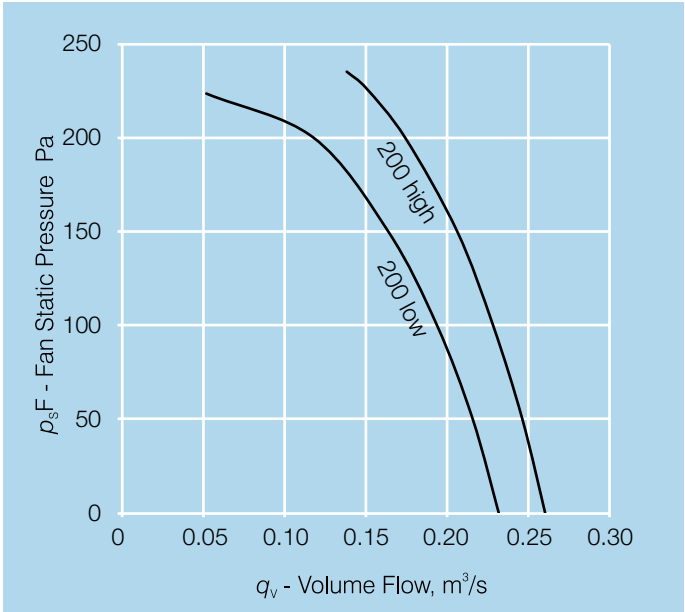
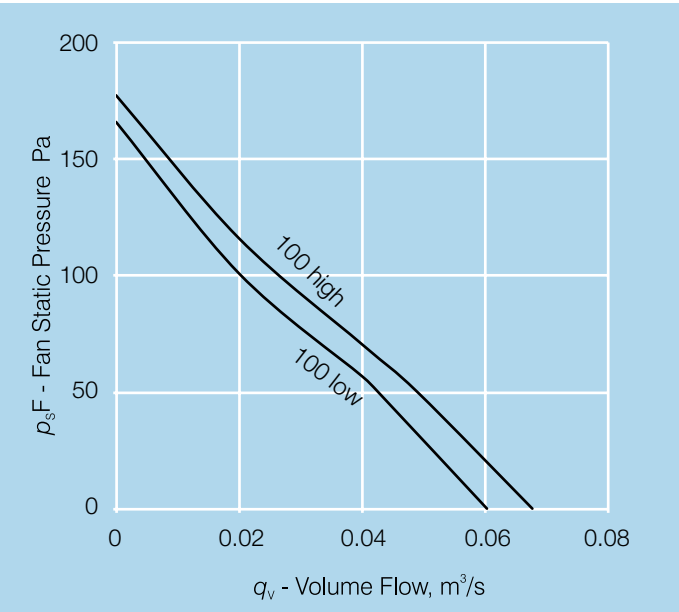
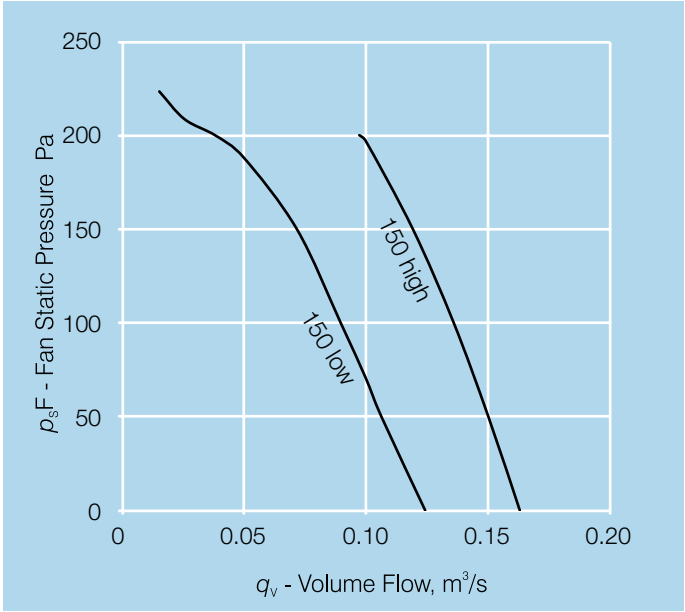

Elta Fans Limited has a policy of continuous product development and improvement and therefore reserves the right to supply products which may differ from those illustrated and described in this publication. Confirmation of dimensions and data will be supplied on request.

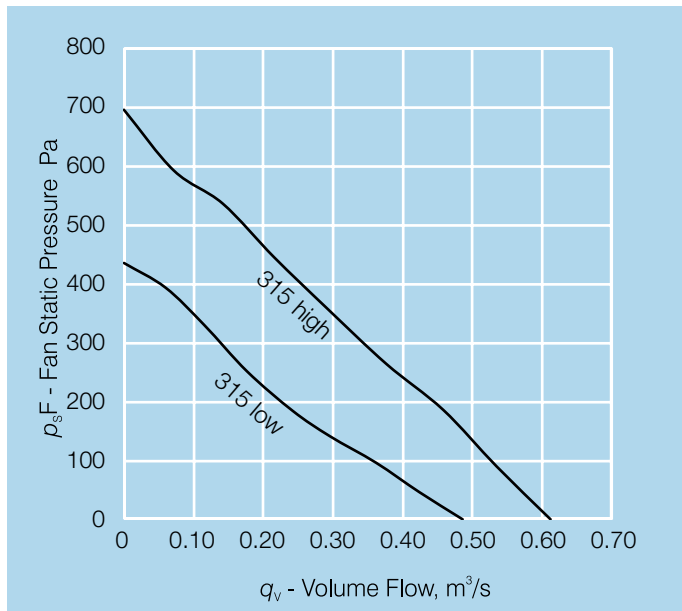

Dimensions

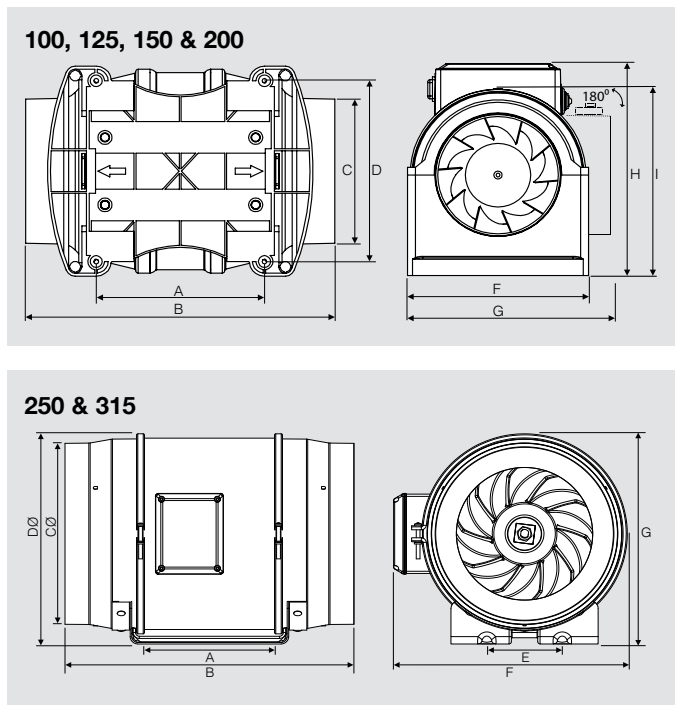

Model Number	Dimensions, mm									Wt, kg
IMF...	A	B	CØ	D	E	F	G	H	I	
100	140	296	97	154	-	179	202	217	190	1.8
125	140	256	124	154	-	179	202	215	190	1.8
150	182	298	147	170	-	194	223	236	211	2.4
200	120	314	197	236	-	254	272	271	236	3.2
250	150	384	246	261	150	310	286	-	-	7.5
315	181	446	311	325	178	386	357	-	-	11



Elta Fans Malaysia Sdn Bhd

Tel **+603 7846 0340**

Fax **+603 7842 1132**

Email **info@eltafans.asia**

No. 147, Jalan TUDM Kampung
Baru Subang, 40150 Shah Alam,
Selangor West Malaysia, Malaysia

eltafans.asia

IMF-01-2020 Issue A



FS 676456

A MEMBER OF  ELTA GROUP